

ROHS

5.0

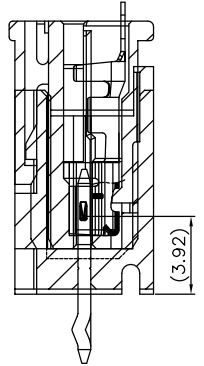

装配剖面示意图

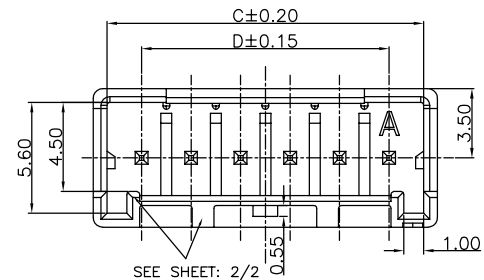
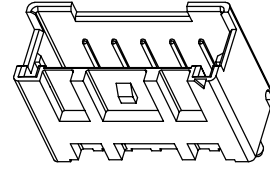
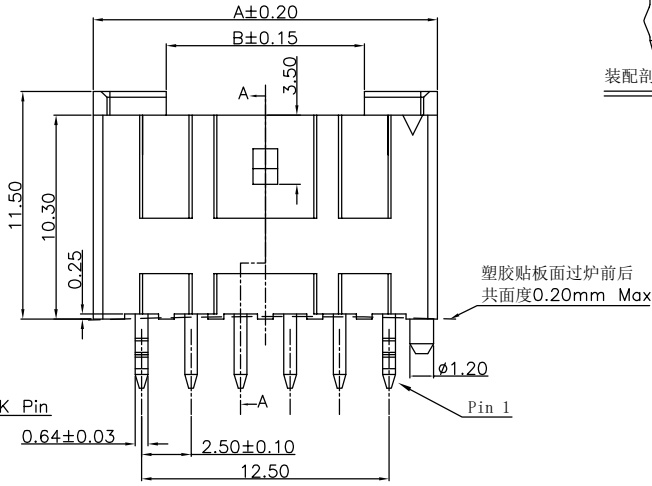
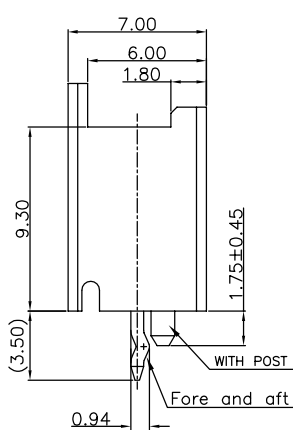

3D VIEW

NO.	COMPONENTS	MATERIALS	SPECIFICATION:FINISH/COLOR	QTY.
1	HOUSING	NYLON UL94V-0	SEE PART NO. LEGEND	1
2	TERMINAL	BRASS SQ=0.64	THE SURFACE: Tin PLATING	N/A

NOTE(UNLESS OTHERWISE SPECIFIED):
 1. ALL MATERIAL MUST BE COMPLY WITH ROHS.
 2. PRODUCT PERFORMANCE:
 2.1 RATED VOLTAGE(MAX.):250V AC/DC
 2.2 RATED CURRENT(MAX.):3.0A AC/DC
 2.3 DIELECTRIC STRENGTH:1500V AC FOR 1 MINUTE BETWEEN ADJACENT TERMINAL, NO BREAKDOWN
 2.4 INSULATION RESISTANCE:1000 MΩ MIN. 500VDC FOR 1 MINUTE BETWEEN ADJACENT TERMINAL
 2.5 CONTACT RESISTANCE:20 mΩ MAX.
 2.6 OPERATING TEMPERATURE:-40°C to +85°C
 3.PART NO. LEGEND: 1WF07-1 X 8 OXX-0000X

WATER CODE
 002:2PIN
 Environmental protection code

7.0

PIN	PART NO	COLOUR	PIN	PART NO	COLOUR
2	1WF07-148002-00006	RED	4	1WF07-148004-00003	BLACK
2	1WF07-148002-00008	YELLOW	4	1WF07-148004-00002	BLUE
2	1WF07-148002-00003	GREEN	4	1WF07-148004-00004	GREEN
2	1WF07-148002-00004	BLUE	5	1WF07-148005-00005	YELLOW
2	1WF07-148002-00001	GREY	5	1WF07-148005-00002	GREEN
2	1WF07-148002-00002	BLACK	5	1WF07-148005-00001	BLACK
2	1WF07-148002-00007	WHITE	5	1WF07-148005-00004	WHITE
2	1WF07-148002-00005	BROWN	5	1WF07-148005-00003	RED
3	1WF07-148003-00002	RED	5	1WF07-128005-00001	BLUE
3	1WF07-148003-00005	GREEN	5	1WF07-148005-00006	BROWN
3	1WF07-148003-00004	GREY	5	1WF07-148005-00007	GREY
3	1WF07-148003-00001	BLACK	6	1WF07-128006-00001	BLUE
3	1WF07-148003-00003	WHITE	6	1WF07-148006-00001	WHITE
3	1WF07-128003-00001	YELLOW	7	1WF07-148007-00001	WHITE
3	1WF07-128003-00002	BLUE	8	1WF07-128008-00001	WHITE
3	1WF07-148003-00006	BROWN	9	1WF07-128009-00001	WHITE
4	1WF07-148004-00001	WHITE			

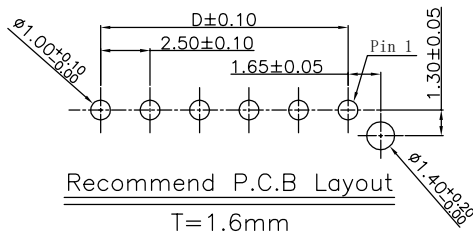

Recommend P.C.B Layout

T=1.6mm

7.0	2022.04.26	Add 7PIN white /5PIN grey specifications	ZengQiuHong
6.0	2022.03.24	MODIFY PRODUCT NUMBER	ShunMingWen
5.0	2019.12.23	Change the environmental standard HF to rohs	Tianhai
4.0	2018.07.28	Revised size	Bains
3.0	2017.09.14	REVISION 4PIN STRENGTHEN	Tian Hai
2.0	2016.12.05	REVISION 2PIN VIEW	Tian Hai
1.0	2015.09.21	NEW	Tain Hai
NO.	DATE	DESCRIPTION	DRAWING

DRAWING: ZengQiuHong	GENERAL TOLERANCE	
	.X:=±0.30	.X*:=±2°
CHECKED:	.XX:=±0.20	.XX*:=±1°
	.XXX:=±0.10	.XXX*:=±0.5°
APPROVAL:	UNIT: MM	PROJECTION:
	SCALE: 1/1	
	SHEET: 1/2	



DESCRIPTION:	PITCH 2.5mm WAFER BOARD	
PART NO:	1WF07-1X80XX-0000X	REV: 7.0
OLD CODE:	WB250BDS-XXTX-XX	SIZE: A4
DRAWING NO:	UK0224	

ROHS

5.0

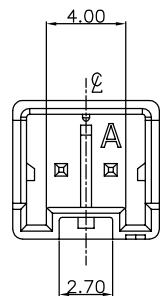

2P

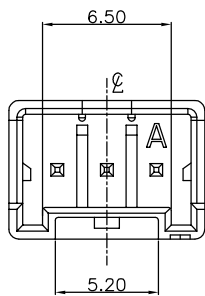

3P

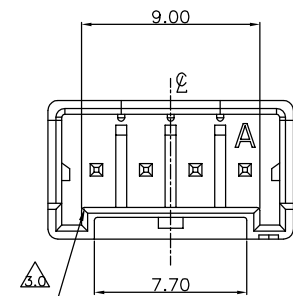

4P

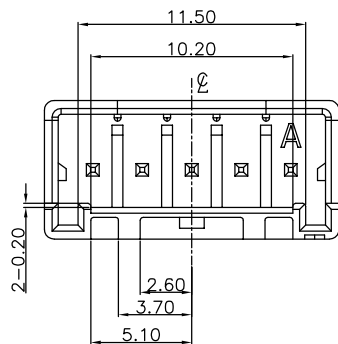

5P

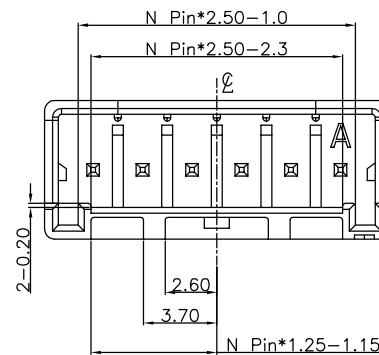

6-16P

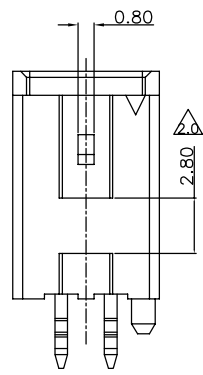

2P

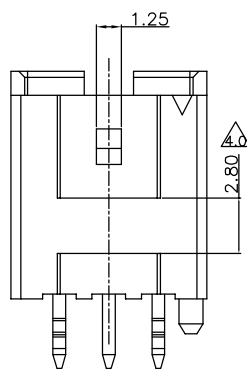

3P

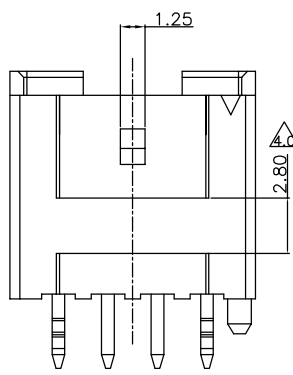

4P

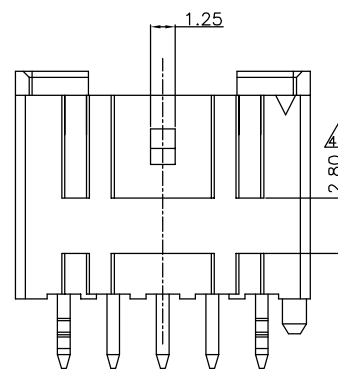

5P

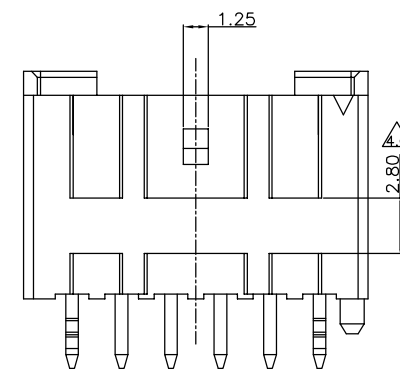

6-16P

PIN	A	B	C	D
2	7.40	—	6.00	2.50
3	9.90	2.50	8.50	5.00
4	12.40	5.00	11.00	7.50
5	14.90	7.50	13.50	10.00
6	17.40	10.00	16.00	12.50
7	19.90	12.50	18.50	15.00
8	22.40	15.00	21.00	17.50
9	24.90	17.50	23.50	20.00
10	27.40	20.00	26.00	22.50
11	29.90	22.50	28.50	25.00
12	32.40	25.00	31.00	27.50
13	34.90	27.50	33.50	30.00
14	37.40	30.00	36.00	32.50
15	39.90	32.50	38.50	35.00
16	42.40	35.00	41.00	37.50

7.0	2022.04.26	Add 7PIN white /5PIN grey specifications	ZengQiuHong
6.0	2022.03.24	MODIFY PRODUCT NUMBER	ShunMingWen
5.0	2019.12.23	Change the environmental standard HF to rohs	Tianhai
4.0	2018.07.28	Revised size	Bains
3.0	2017.09.14	REVISION 4PIN STRENGTHEN	Tian Hai
2.0	2016.12.05	REVISION 2PIN VIEW	Tian Hai
1.0	2015.09.21	NEW	Tain Hai
NO.	DATE	DESCRIPTION	DRAWING

DRAWING:

ZengQiuHong

CHECKED:

APPROVAL:

GENERAL TOLERANCE

.X:=±0.30 .X*:=±2°
.XX:=±0.20 .XX*:=±1°
.XXX:=±0.10 .XXX*:=±0.5°

UNIT: MM

PROJECTION:

SCALE: 1/1

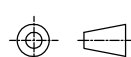

SHEET: 2/2

CHIN-BAN
Electronic Technology

DESCRIPTION: PITCH 2.5mm WAFER BOARD

PART NO: 1WF07-1X80XX-0000X

REV: 7.0

OLD CODE: WB250BDS-XXTX-XX

SIZE: A4

DRAWING NO: UK0224

RoHS



product (产品)

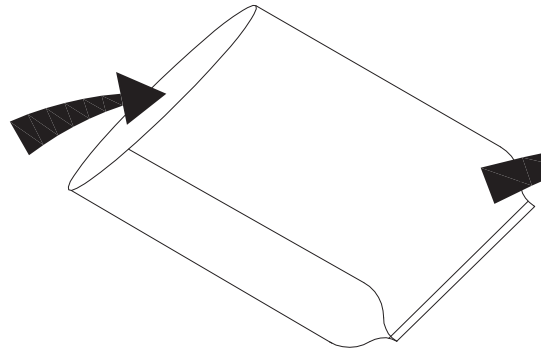

PE bag (without holes)
PE袋(无孔)

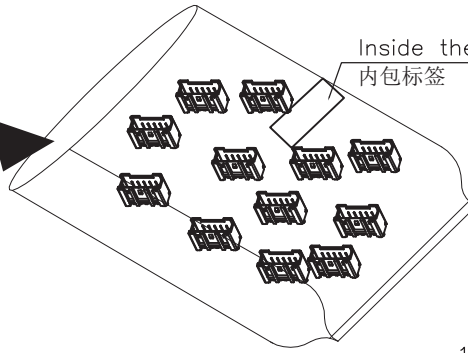

① Put in bag 装包 (N pcs/bag)

Inside the package labels
内包标签

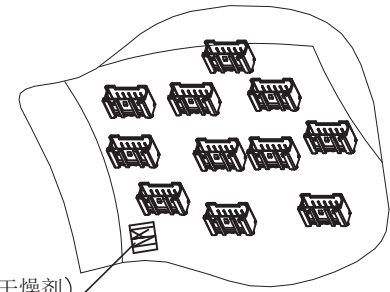

② Release desiccant seal
(放干燥剂密封)

1 PCS/desiccant(干燥剂)

备注:

1. No hole PE bag Size: 18*25
(无孔PE袋尺寸: 18*25)
2. Each package contains N pcs of finished products, and the bag mouth is sealed after the desiccant is put
(每包装成品N pcs,放干燥剂后袋口密封)
3. Environmental requirements :RoHS.
(环保要求:RoHS)
4. The size of the outer carton is 40*28*18CM
(外纸箱尺寸为: 40*28*18CM)

PIN 数	pcs/包	N包/内箱	PCS/箱
02~03	1000 PCS	10 包	10000 PCS
04~06	500 PCS	10 包	5000 PCS
07~09	400 PCS	10 包	4000 PCS
10	300 PCS	10 包	3000 PCS

There is a gap to fill
(有间隙需要填充)

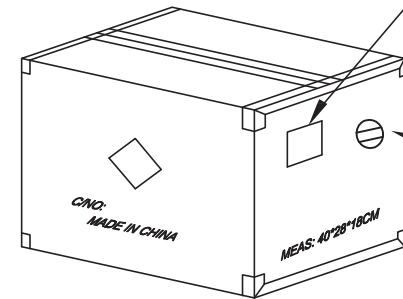

Outside carton label
外箱标签

Environmental label
环保标签

10bag/box

③ 10包/箱

5.0				DRAWING: Bains	GENERAL TOLERANCE .X:=±0.50 .X*::=±2* .XX:=±0.30 .XX*::=±1* .XXX:=±0.20 .XXX*::=±0.5*	CHIN-BAN Electronic Technology	
4.0							
3.0				CHECKED:	UNIT: MM PROJECTION:	DESCRIPTION: PITCH 2.5mm WAFER BOARD-PACKING	
2.0	2022.04.22	MODIFY PRODUCT NUMBER	ShunMingWen				
1.0	2017.09.06	NEW	TianHai	APPROVAL:	SCALE: 1/1	PART NO: F-1WF07-1X80XX-0000X	REV: 2.0
NO.	DATE	DESCRIPTION	DRAWING			SHEET: 1/1	OLD CODE: F-WB250BDS-XXTX-XX

5.0				DRAWING: Bains	GENERAL TOLERANCE .X:=±0.50 .X*::=±2* .XX:=±0.30 .XX*::=±1* .XXX:=±0.20 .XXX*::=±0.5*	CHIN-BAN Electronic Technology	
4.0							
3.0				CHECKED:	UNIT: MM PROJECTION:	DESCRIPTION: PITCH 2.5mm WAFER BOARD-PACKING	
2.0	2022.04.22	MODIFY PRODUCT NUMBER	ShunMingWen				
1.0	2017.09.06	NEW	TianHai	APPROVAL:	SCALE: 1/1	PART NO: F-1WF07-1X80XX-0000X	REV: 2.0
NO.	DATE	DESCRIPTION	DRAWING			SHEET: 1/1	OLD CODE: F-WB250BDS-XXTX-XX

5.0				DRAWING: Bains	GENERAL TOLERANCE .X:=±0.50 .X*::=±2* .XX:=±0.30 .XX*::=±1* .XXX:=±0.20 .XXX*::=±0.5*	CHIN-BAN Electronic Technology	
4.0							
3.0				CHECKED:	UNIT: MM PROJECTION:	DESCRIPTION: PITCH 2.5mm WAFER BOARD-PACKING	
2.0	2022.04.22	MODIFY PRODUCT NUMBER	ShunMingWen				
1.0	2017.09.06	NEW	TianHai	APPROVAL:	SCALE: 1/1	PART NO: F-1WF07-1X80XX-0000X	REV: 2.0
NO.	DATE	DESCRIPTION	DRAWING			SHEET: 1/1	OLD CODE: F-WB250BDS-XXTX-XX